

Homogenizer HL4

- Max. 103 (gal/min)
- Max. Homogenizing pressure up to 10,153 PSI
- Poppet valve and ball valve execution
- Max. motor power: 177 hp
- Weight with motor approx. 11,905 lbs
- Customized execution
- Control cabinet incl. PCL control and touchpanel
- Optional in aseptic execution with sterile water unit
- Designed and made in Germany



Technical changes reserved!

Poppet valves

For low viscosity and slightly abrasive products

Model	Max. Pressure (PSI)	Max. Capacity (GPM)
HL4-140T	2,031	103
HL4-180T	2,611	81
HL4-200T	2,901	70
HL4-250T	3,626	59
HL4-300T	4,351	51
HL4-350T	5,076	42
HL4-550T	7,977	22

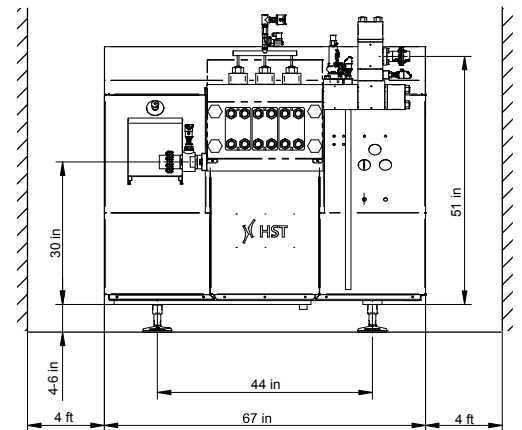

Ball valves

For high viscosity and abrasive products

Model	Max. Pressure (PSI)	Max. Capacity (GPM)
HL4-150K	2,176	86
HL4-200K	2,901	66
HL4-250K	3,626	57
HL4-300K	4,351	49
HL4-350K	5,076	41
HL4-550K	7,977	24
HL4-700K	10,153	19

